

# Montageanleitung profi-set

## 264 3HE

### 1. Montage der Modulschienen an einer Seitenwand

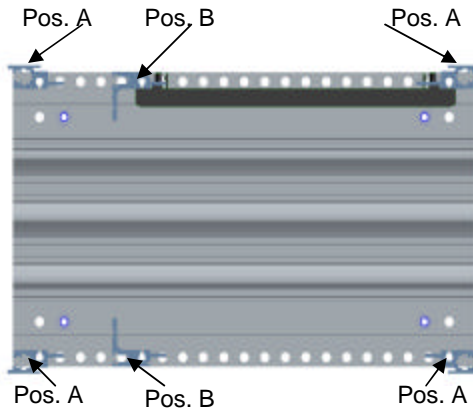

Pos. A: 4x Standard Modulschiene

Pos. B: 2x Modulschiene mit integrierter Montagewiseite  
oder BUS - Modulschiene

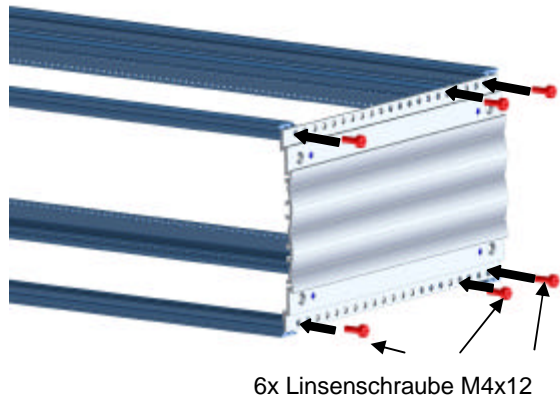

6x Linsenschraube M4x12

### 2. Montage von Gewindeleisten & Schiebemuttern

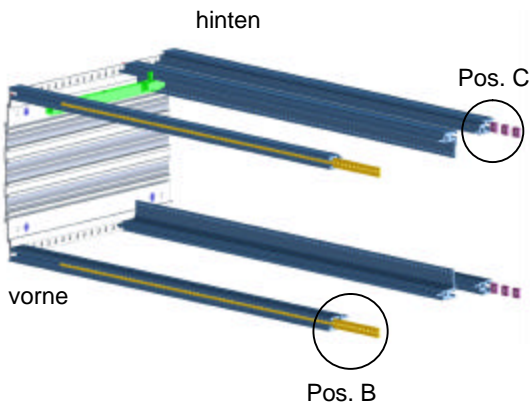

C. hinten



Mutterhalter  
Mutter

Schiebemutter  
2x3 bei 84-63TE  
2x2 bei 42-28 TE

B. vorne

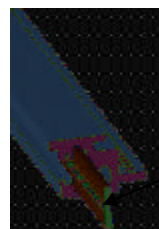

2x Gewindeleiste

### 3. Montage der zweiten Seitenwand

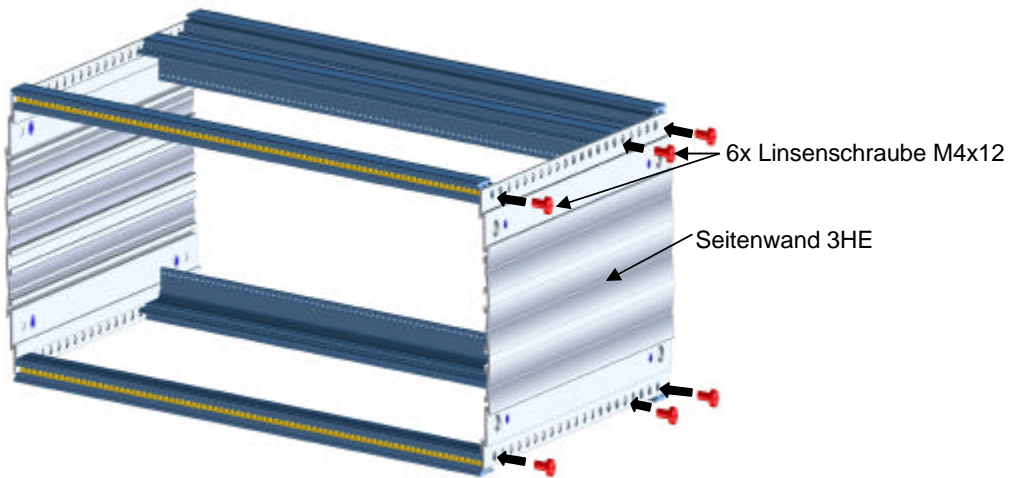

### 4. Montage der Griffe am Frontwinkel

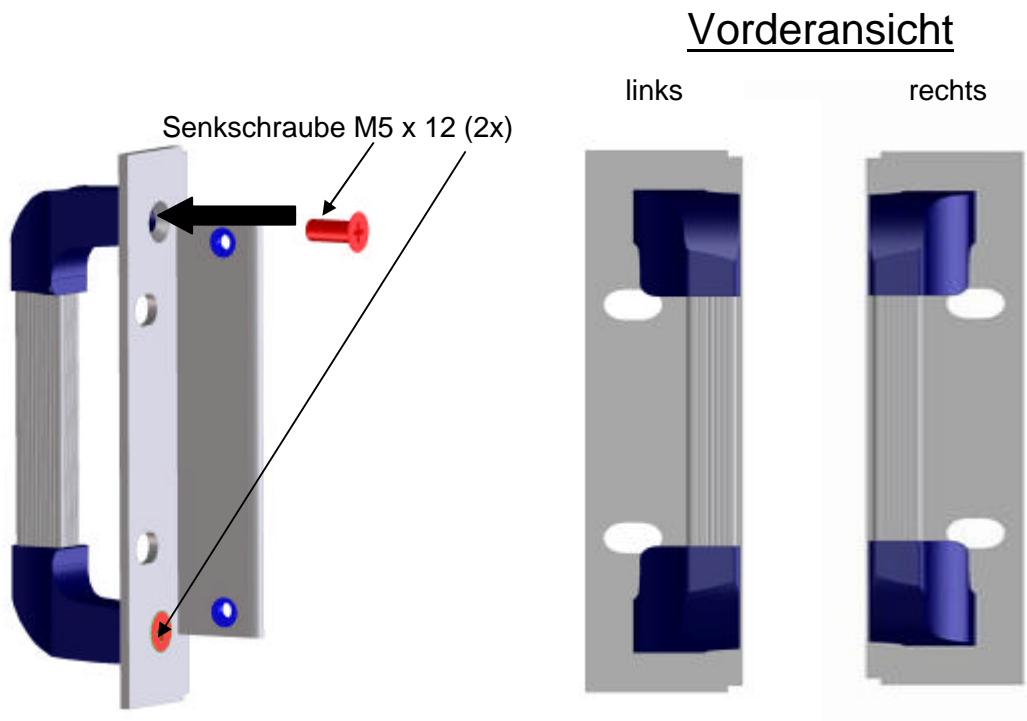

## 5. Montage 19" Frontwinkel (19" Einschub)

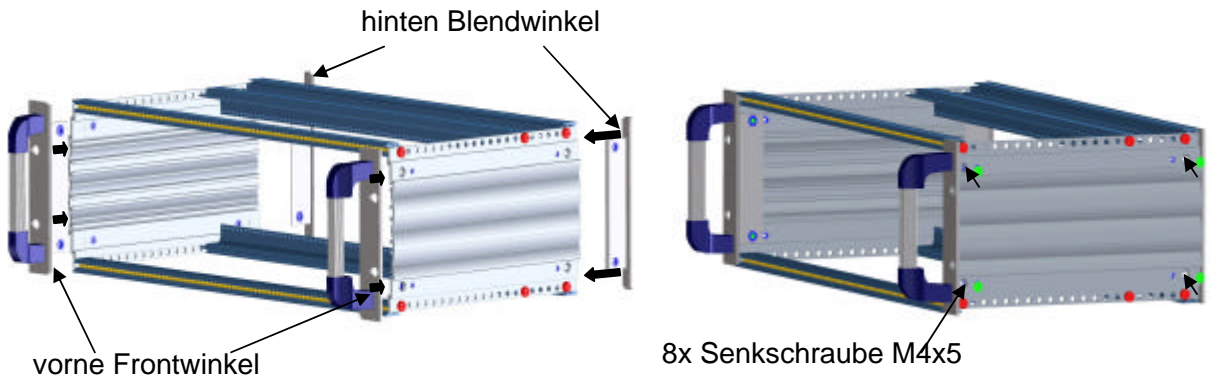

## 5. Montage der Blendwinkel (Tischgehäuse)

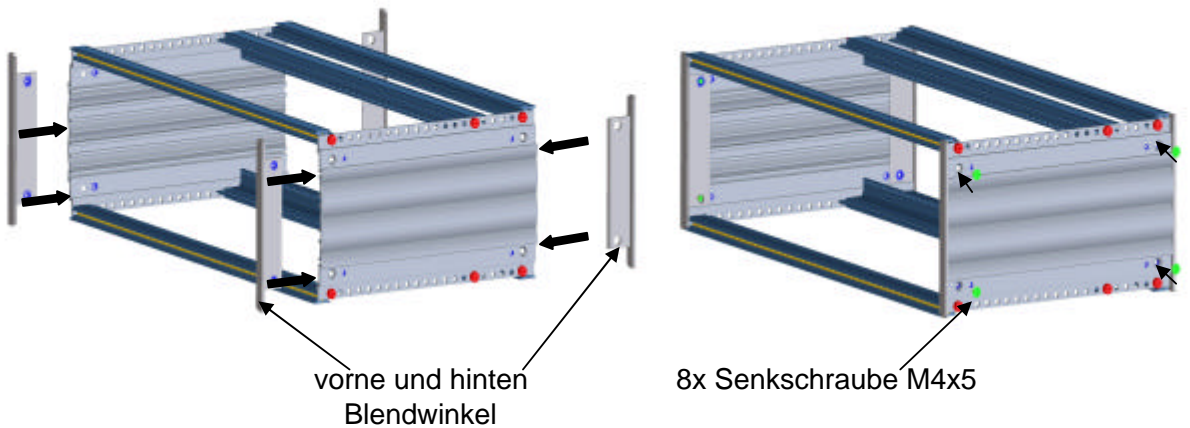

## 6. Vormontage der Deck - /Bodenbleche

### Blenden

2x rechte und  
2x linke Ausführung



Schritt 1.

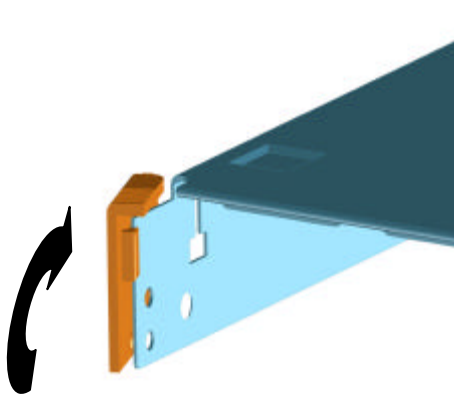

Schritt 2.

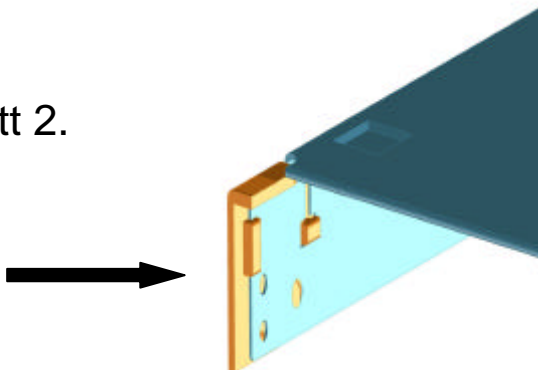

Schritt 3.

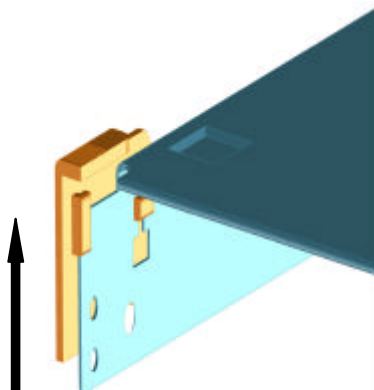

## 7. Montage der Deck -/ Bodenbleche

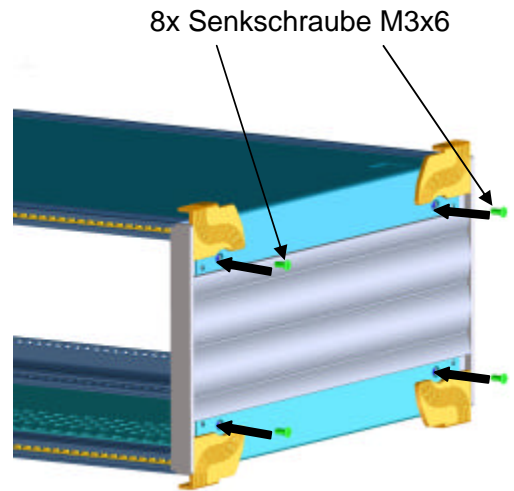
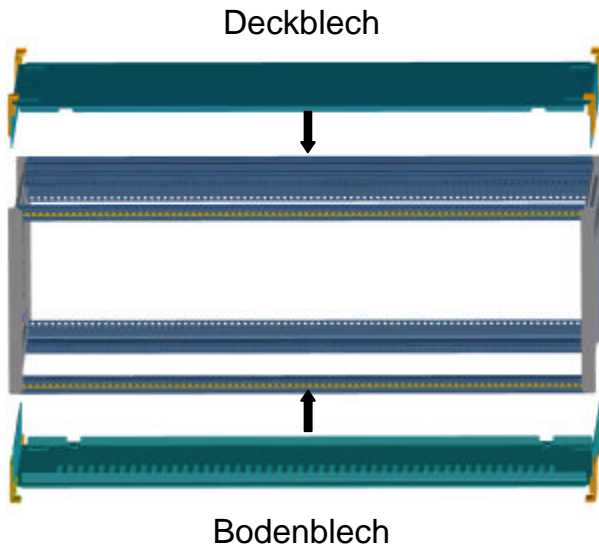

Drücken / Push

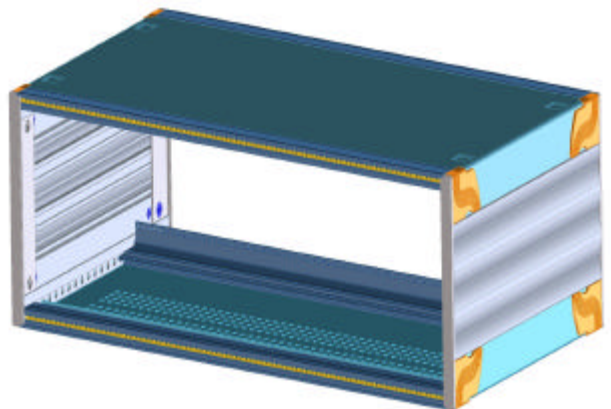
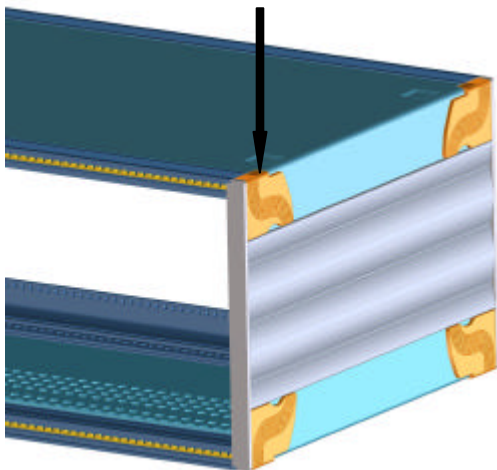

# Montageanleitung profi-set 264 EMV-Federn

